

**DEUBLIN**<sup>®</sup>  
*Engineered for Performance*



**MULTI-PASSAGE SOFT-SEAL ROTATING UNIONS**

[www.deublin.com](http://www.deublin.com)

# DEUBLIN Multi-Passage Soft-Seal Rotating Unions

A rotating union connects a stationary pressurized supply line to a rotating machine part such as a cylinder, roll, spindle, clutch, etc. It can be used to convey virtually any liquid or gas: steam for heating, water or water/glycol solutions for cooling, hydraulic fluids, cutting fluids, air, inert gas, or even vacuum. The task becomes more complicated when more than one media must be conveyed simultaneously. This is the role of a multi-passage union – to provide multiple, independent passages for the same or several different media to different rotating feed points within the same axis.

Typically, each passage is isolated from all other passages and different media are not allowed to mix. The key to reliable function of a multi-passage union thus lies in the sealing technology. Different seal types are dictated by the operating conditions – temperature, pressure, rotation speed, torque, medium chemistry and passage size.

Because each application is unique in terms of passage diameter, number of passages, flange configuration and operating conditions, Deublin brings to bear unparalleled engineering expertise and experience to match your operational needs. Whether a standard model can be applied or a custom solution is required, you can rely on Deublin for the optimal solution with long-term performance and reliability.

## TYPICAL APPLICATIONS FOR MULTI-PASSAGE UNIONS

- Steel industry: ladle turrets for continuous casting operations
- Plastics & rubber industries: injection and rotary molding operations
- Machining operations: workholding and clamping functions
- Aerospace manufacturing and flight simulators
- Industrial cranes
- Rail transportation
- De-scaling operations
- ...and many more



*Deublin Multi-Passage unions testing fixture*

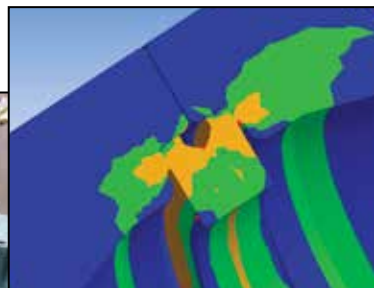

*Designed and engineered  
with Finite Element Analysis  
(FEA), and validated by  
extensive testing*

# DEUBLIN Multi-Passage Sealing Solutions

Deublin Multi-Passage Soft-Seal unions are optimized for the operating parameters of the application such as speed, torque, media pressure, operating temperature, physical size and other factors. Hardened chrome sealing surfaces are standard to ensure minimal wear and long service life.

- **Plastomeric Seals** – a combination of plastic and elastomer – offer superior resistance to high temperatures and pressures compared to traditional elastomers. Seal geometry and treatment of the rotor mating surface are carefully matched to the media, rotational speed, and pressure of the specific application.
- Deublin's proprietary seal chemistry and geometry maximize performance including reduced friction and torque, and extended service life. This performance advantage allows Deublin multi-passage soft-seal unions to be used for a wide variety of applications.

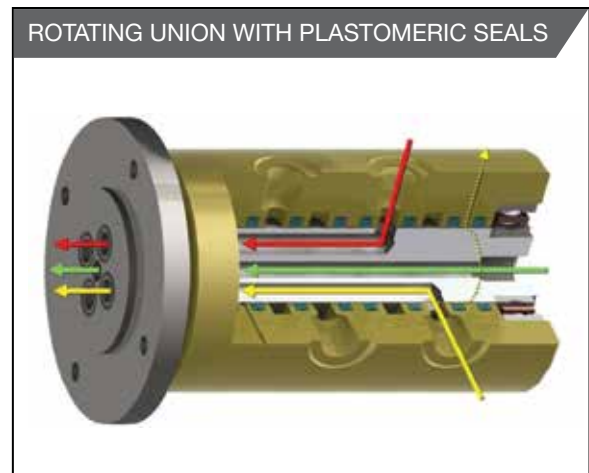

**Typical commercial seal design:**  
Inner pad may have different cross-sectional geometry depending on media and operating conditions.



**Deublin proprietary seal design:**  
Use a variety of materials and geometries depending on media and operating conditions.

# DEUBLIN Product Definition

Deublin Multi-Passage Soft-Seal rotating unions can be used in the widest variety of applications and media. Typical media includes the following:

- Hydraulic Oil
- Argon
- Water
- Grease
- Water-Glycol
- Coolant
- Air (dry/lubricated)
- Cutting Oil
- Nitrogen
- Vacuum

For media not listed above, please contact Deublin.

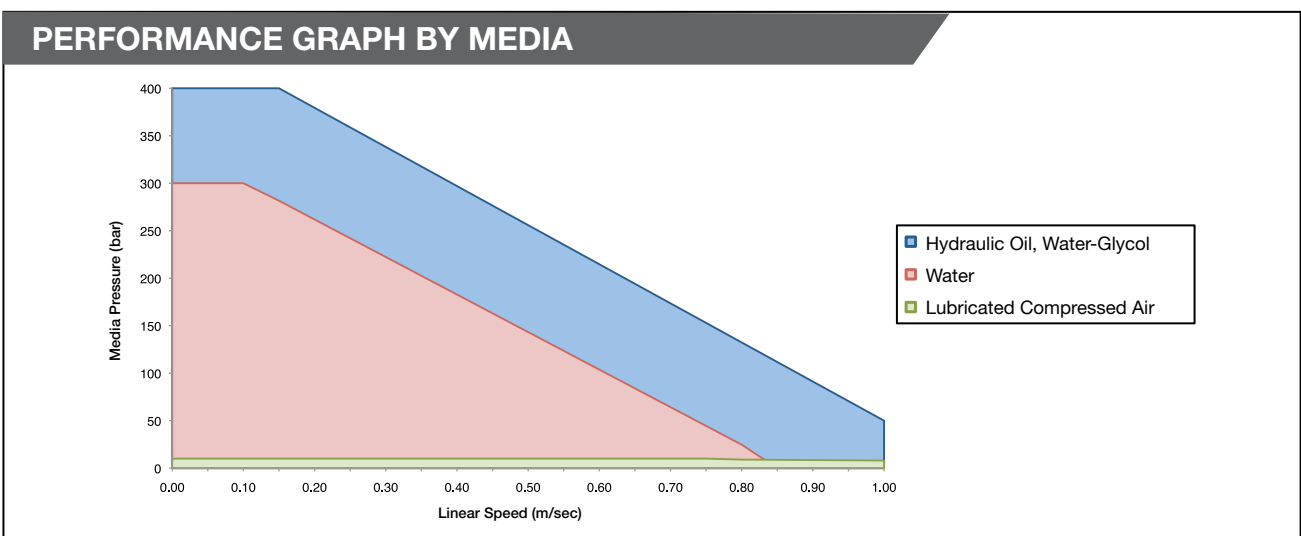

### TYPICAL MEDIA & OPERATING CONDITIONS

Media	Pressure		Temperature		Speed
	bar	psi	°C	°F	
Hydraulic Oil	≤ 400	≤ 5,800	≤ 80	≤ 175	Maximum rotational speed is a function of media, pressure and rotor diameter (see above chart).  Note: Typical speeds ≤ 50 RPM
Water-Glycol	≤ 400	≤ 5,800			
Water	≤ 300	≤ 4,350			
Air (dry/lubricated)	≤ 12	≤ 175			
Nitrogen	≤ 12	≤ 175			
Argon	≤ 12	≤ 175			
Coolant	≤ 120	≤ 1,740			
For operating conditions exceeding above parameters, please contact Deublin.					

**WARNING** DEUBLIN unions should not be used to convey flammable media (flash point ≤ 140°F or 60°C) as leakage may result in explosions or fires. DEUBLIN unions should be used in accordance with standard safety guidelines for the media, and in a well-ventilated area. The use of our product on hazardous or corrosive media is strictly forbidden.



# DEUBLIN Product Definition

Deublin offers Multi-Passage Soft-Seal rotating unions that are standard, semi-custom and custom. When possible, Deublin recommends standard models, but will recommend semi-custom or custom models depending on the unique requirements of each application.

Semi-Custom unions can have different port sizes on the same union, SAE port connections and/or larger center bore (up to 50 mm).

Custom unions have no limitation on dimensions, port sizes, port connection specifications and center bore dimensions.

## STANDARD FEATURES

- Ports/Passages: 2 to 10
- Sizes: 1/8" to 1/2", NPT or BSP
- Materials of Construction:
  - Flanged rotor: AISI 420 with aluminum housing
  - Bearings: dual, widely-spaced ball bearings ensure smooth running and minimize impact of potential side-loading
- Optional center bore up to 25 mm (1") for electrical slip ring wires

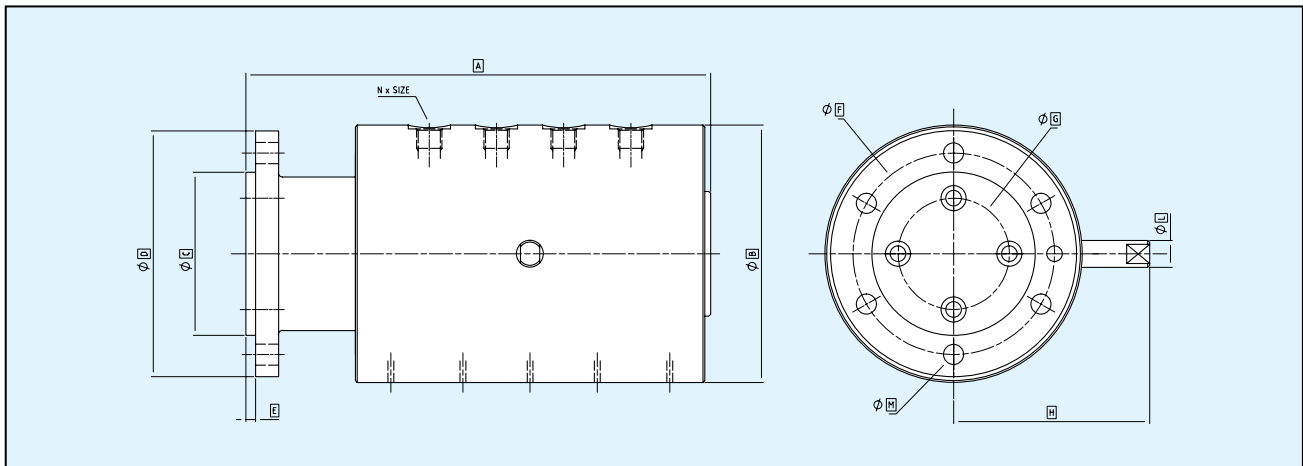

	Port Size 1/8" – 1/4"				Port Size 3/8" – 1/2"				
	2	4	6	8	2	4	6	8	
<b>A</b>	160	245	315	385	<b>A</b>	165	270	356	440
<b>B</b>	110	135	155	155	<b>B</b>	120	135	155	155
<b>C</b>	73	85	105	105	<b>C</b>	73	85	105	105
<b>D</b>	110	128	152	152	<b>D</b>	110	128	152	152
<b>E</b>	5	5	7	7	<b>E</b>	5	5	7	7
<b>F</b>	93	105	128	128	<b>F</b>	93	105	128	128
<b>G</b>	44	58	78	78	<b>G</b>	38	53	73	73
<b>H</b>	90	115	130	130	<b>H</b>	95	115	130	130
<b>L</b>	12	14	16	16	<b>L</b>	12	14	16	16
<b>M</b>	8.5	105	12.5	12.5	<b>M</b>	8.5	10.5	12.5	12.5
<i>Unions Also Available With Central Bore</i>					<i>Unions Also Available With Central Bore</i>				
<b>Max Ø</b>	25	40	50	50	<b>Max Ø</b>	12	25	45	45

Note: all dimensions, except port sizes, in mm

# Examples of Applications

Deublin designs and manufactures a complete range of rotating unions from simple, single channel models used to prevent flex-hoses from twisting, to 12-port unions used on machine tool index tables, to massive, multi-channel unions used for ladle turrets in continuous casting machines. Deublin Multi-Passage Soft-Seal unions are used in applications that may require air, water, oil, grease, argon and other media.

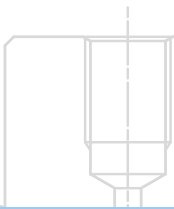

**Application:** Machine Tool  
**Passages:** 12

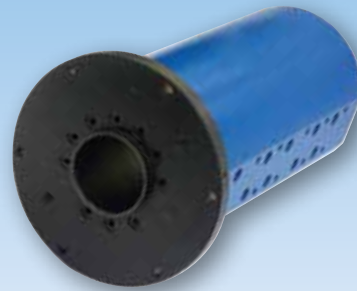

**Application:** Machine Tool index table  
**Passages:** 8 with large center bore

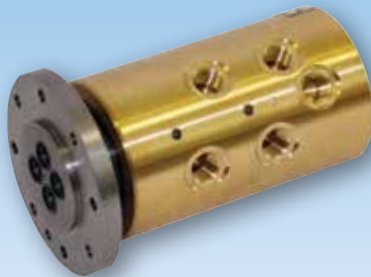

**Application:** General  
**Passages:** 4 + 1 drain



**Application:**  
Ladle Turret  
**Passages:** 22

# Examples of Applications



**Application:** Index Table  
**Passages:** 16

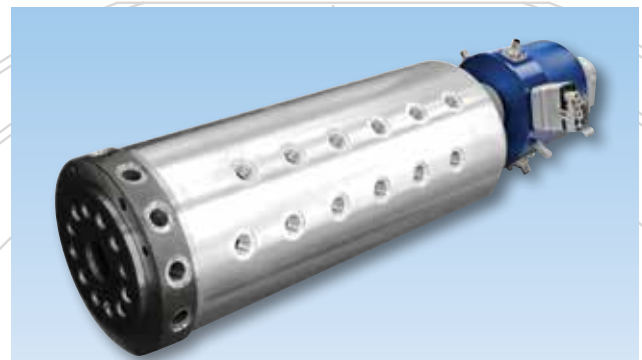

Multi-Passage Soft-Seal unions can be combined with Electrical Slip Rings



**Application:** Steel Plant  
**Passages:** 5 with large center bore



**Application:** Coil Winding  
**Passages:** 6



Since its establishment in 1945, Deublin has consistently adhered to a policy of producing the best product of its kind in the market. The result of this policy has been constant growth through the years. For this progress we are grateful to our many loyal customers. We cordially invite you to visit our modern manufacturing facilities in Waukegan, Illinois; Hofheim, Germany; Monteveglio, Italy; and Dalian, China.

Sincerely,

Donald L. Deubler  
Chairman of the Board



Global Headquarters in Waukegan, Illinois, U.S.A.



Hofheim, Germany



Monteveglio, Italy



Dalian, China

## AMERICAS

### DEUBLIN USA

2050 Norman Drive  
Waukegan, IL 60085-6747 U.S.A.  
Phone: +1 847 689-8600  
Fax: +1 847 689-8690  
e-mail: customerservice@deublin.com

### DEUBLIN Brazil

Rua Santo Antonio, 1426 - Vila Galvão  
Guarulhos, São Paulo Brazil 07071-000  
Phone: +55 11-2455-3245  
Fax: +55 11-2455-2358  
e-mail: deublinbrasil@deublinbrasil.com.br

### DEUBLIN Canada

3090 Boul. Le Carrefour, Suite 505  
Laval, Québec H7T 2J7 Canada  
Phone: +1 514 745-4100  
Fax: +1 514 745-8612  
e-mail: customerservice@deublin.com

### DEUBLIN Mexico

Norte 79-A No. 77, Col. Claveria  
02080 Mexico, D.F.  
Phone: +52 55-5342-0362  
Fax: +52 55-5342-0157  
e-mail: deublin@prodigy.net.mx

## ASIA

### DEUBLIN China

No. 2, 6th DD Street, DD Port Dalian  
Liaoning Province, 116620, P.R. China  
Phone: +86 411-87549678  
Fax: +86 411-87549679  
e-mail: info@deublin.cn

China Merchants Plaza 12th Floor,  
Suite (East) 1208, 333 Chengdubei Road  
Shanghai, 200041, P.R. China  
Phone: +86 21-52980791  
Fax: +86 21-52980790  
e-mail: service@deublin.cn

### DEUBLIN Asia Pacific

51 Goldhill Plaza, #11-11/12  
Singapore 308900  
Phone: +65 6259-9225  
Fax: +65 6259-9723  
e-mail: deublin@singnet.com.sg

### DEUBLIN Japan

2-13-1, Minamihanayashiki  
Kawanishi City 666-0026, Japan  
Phone: +81 72-757-0099  
Fax: +81 72-757-0120  
e-mail: customerservice@deublin-japan.co.jp

2-4-10-3F Ryogoku  
Sumida-Ku, Tokyo 130-0026, Japan  
Phone: +81 35-625-0777  
Fax: +81 35-625-0888  
e-mail: customerservice@deublin-japan.co.jp

### DEUBLIN Korea

Star Tower #1003, Sangdaewon-dong 223-25,  
Jungwon-gu, Seongnam-si, Gyeonggi-do,  
South Korea  
Phone: +82-31-8018-5777  
Fax: +82-31-8018-5780  
e-mail: customerservice@deublin.co.kr

## EUROPE

### DEUBLIN Germany

Nassaustraße 10  
65719 Hofheim a. Ts., Germany  
Phone: +49 6122-8002-0  
Fax: +49 6122-15888  
e-mail: info@deublin.de

### DEUBLIN Italy

Via G. Rossa 9, Loc. Monteveglio  
40053 Comune di Valsamoggia (BO), Italy  
Phone: +39 051-835611  
Fax: +39 051-832091  
e-mail: mauro.pozzato@deublin.it

Via Giovanni Falcone 36  
20010 Bareggio (MI), Italy  
Phone: +39 02-90312711  
Fax: +39 02-90278189  
e-mail: info@deublin.it

### DEUBLIN Austria

Trazerberggasse 1/2  
1130 Wien, Austria  
Phone: +43 1-8768450  
Fax: +43 1-876845030  
e-mail: info@deublin.at

### DEUBLIN France

61 bis, Avenue de l'Europe  
Z.A.C de la Malnoue  
77184 Emerainville, France  
Phone: +33 1-64616161  
Fax: +33 1-64616364  
e-mail: service.client@deublin.fr

### DEUBLIN Poland

ul. Kamienskigo 201-219  
51-126 Wroclaw, Poland  
Phone: +48 71-3528152  
Fax: +48 71-3276278  
e-mail: info@deublin.pl

### DEUBLIN Russia

ul. Kosygina, 13, 5th entrance, 1-st floor  
119334, Moscow, Russia  
Phone: +7 495 647-14-34  
Fax: +7 495 938-89-49  
e-mail: info@deublinrussia.ru

### DEUBLIN Spain

C/Lola Anglada, 20 local 1,  
08228 Terrassa, Spain  
Phone: +34 93-2211223  
Fax: +34 93-2212093  
e-mail: deublin@deublin.es

### DEUBLIN Sweden

Cylindervägen 18, Box 1113  
13 126 Nacka Strand, Sweden  
Phone: +46 8 716 2033  
Fax: +46 8 601 3033  
e-mail: info@deublin.se

### DEUBLIN United Kingdom

6 Sopwith Park, Royce Close, West Portway  
Andover SP10 3TS, UK  
Phone: +44 1264-333355  
Fax: +44 1264-333304  
e-mail: deublin@deublin.co.uk



Deublin products &  
services are available  
throughout the world.

[www.deublin.com](http://www.deublin.com)